

Nu & Linea Integrated Showers

Available layouts - Glass enclosure included - Hinges left or right

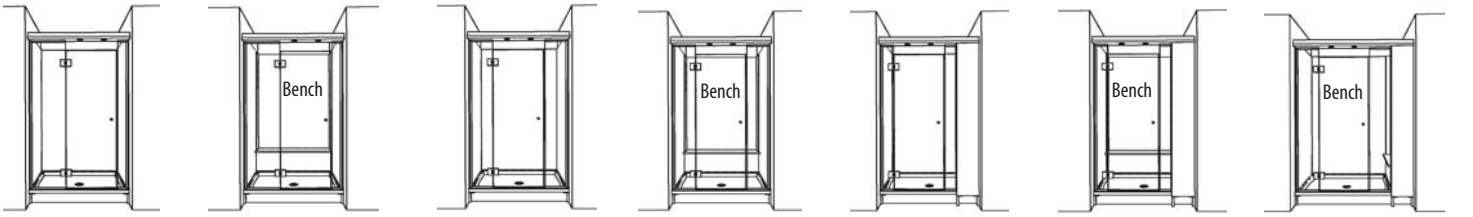

Showers between 3 walls - 1 off-centered door
41" to 71" L x 31 1/2" to 47 1/2" D

Showers between 3 walls - 1 centered door
34" to 71 9" L x 31 1/2" to 47 1/2" D

Showers between 3 walls - 1 centered door
47" to 71" L x 33 3/4" to 49 3/4" D

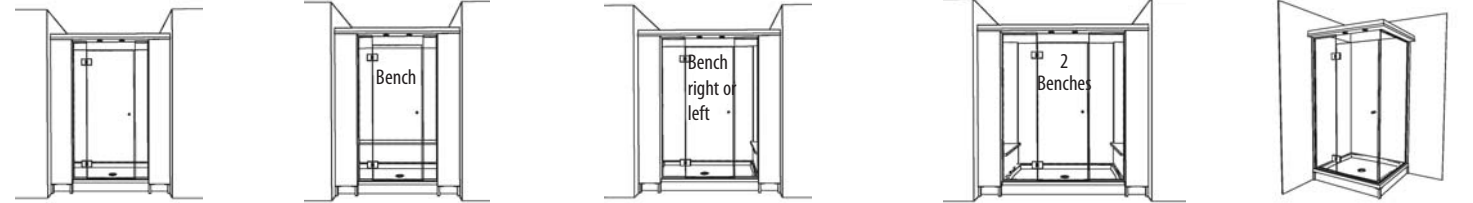

Showers between 3 walls - 1 centered door
59" to 71" L x 33 3/4" or 43 3/4" D

Showers between 3 walls - 1 centered door
59" to 71" L x 43 1/8" or 53 1/8" D

Showers between 3 walls - 1 centered door
56 3/8" to 80 3/8" L x 33 3/4" to 49 3/4" D

Showers between 3 walls - 1 centered door
59 3/4" to 89 3/4" L x 33 3/4" to 49 3/4" D

Corner showers - 1 door on the L
35 1/2" to 71 1/2" L x 41 1/2" D



Corner showers - 1 door on the L
41 1/2" or 71 1/2" L x 37 3/4" to 43 3/4" D

Corner showers - 1 door on the L
44 7/8" to 80 7/8" L x 43 3/4" D

Corner showers - 1 door on the Lenght
37 3/4" to 73 3/4" L x 35 1/2" to 41 1/2" D

Corner showers - 1 door on the Lenght
37 3/4" to 73 3/4" L x 44 7/8" to 50 7/8" D

Corner showers - 1 door on the L
43 3/4" to 73 3/4" L x 37 3/4" to 43 3/4" D

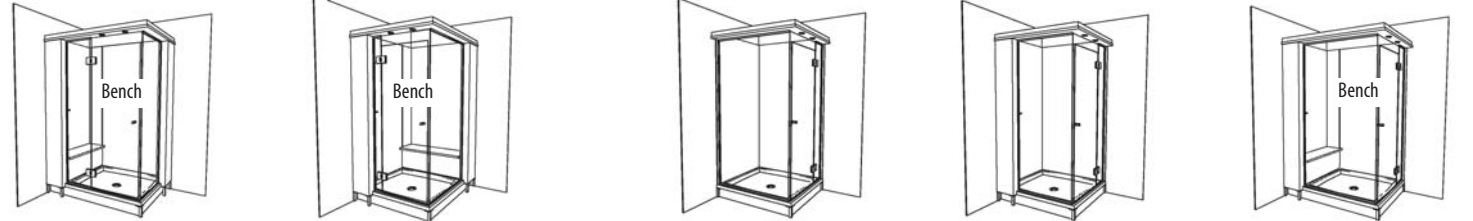

Corner showers - 1 door on the Lenght
47 1/8" to 83 1/8" L x 37 3/4" to 43 3/4" D

Corner showers - 1 door on the Lenght
43 3/4" to 73 3/4" L x 47 1/8" to 53 1/8" D

Corner showers - 1 door on the depth (D)
35 1/2" to 71 1/2" L x 35 1/2" to 41 1/2" D

Corner showers - 1 door on the depth (D)
35 1/2" to 71 1/2" L x 37 3/4" to 43 3/4" D

Corner showers - 1 door on the depth (D)
44 7/8" to 80 7/8" L x 37 3/4" to 43 3/4" D



Corner showers - 1 door on the Depth (D)
37 3/4" to 73 3/4" L x 44 7/8" to 50 7/8" D

Corner showers - 1 door on the Depth (D)
37 3/4" to 73 3/4" L x 47 1/8" to 53 1/8" D

Corner showers - 2 doors
35 1/2" to 71 1/2" L x 35 1/2" to 41 1/2" D

Corner showers - 2 doors
35 1/2" to 71 1/2" L x 37 3/4" to 43 3/4" D

Corner showers - 2 doors
37 3/4" to 73 3/4" L x 35 1/2" to 41 1/2" D

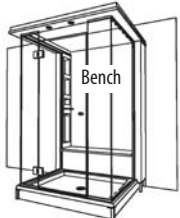
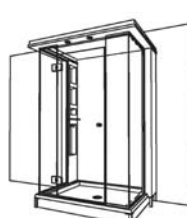

Showers with back wall only - 1 door centered on the Lenght (L)
48" to 72" L x 35 1/2" to 41 1/2" D

Showers with back wall only - 1 door centered on the Lenght (L)
52 1/2" to 76 1/2" L x 35 1/2" to 41 1/2" D

Showers with back wall only - 1 door centered on the Lenght (L)
52 1/2" to 76 1/2" L x 44 7/8" to 50 7/8" D

Glass enclosure included
Hinges left or right





Nu & Linea Shower

Technical specifications Planning notes

A. ROOM SET UP

1. BUILDING THE WALLS

1) We recommend you install a stud at the location where you will attach the column or the U-shaped channel and the extremity of the shower head to ensure they are solidly attached.

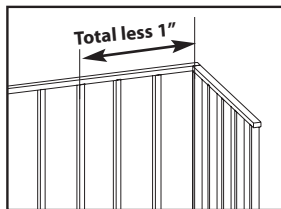

Total less 1" = total dimension indicated in the price pages less 1".

2. PREPARATION FOR PLUMBING

Drain height:
Minimum height 8".

Drain placement: Refer to the dimensions indicated in the price pages. **N.B.** Pay attention to the direction of the shower: left or right.

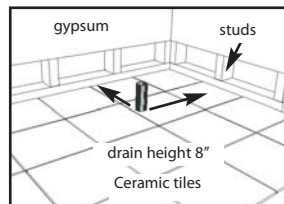

Column for body jets: With the column for body jets option, pass the plumbing to the inside of the stud in step 1.

3. PREPARATION FOR ELECTRICITY

See previous page for the 110V pigtail positioning.

4. WALL SURFACE

With Vanico-Maronyx fiberglass panels: gypsum board.

With ceramic: Duroc sheets.
You must complete the shower installation before laying the ceramic tiles on the walls.

5. FLOOR SURFACE

The shower is installed directly on the floor surface (tiles).

B. INSTALLATION STEPS

1. PLATFORM Level and attach the platform to the floor and to the studs.

2. BENCH Attach bench if any.

3. SHOWER PAN Attach shower pan to the platform (silicone) and to the studs (screws) and, if any, to the bench.

4. TOE-KICK Assemble toe-kick then insert under the shower pan and against the wall.

5. a) WITHOUT COLUMN

1. Install fiberglass panels on gypsum.

5. b) WITH 1 COLUMN

1. Install column on receptor and on gypsum.
2. Install fiberglass panels.

5. c) WITH 2 COLUMNS

1. Install the 1st column on receptor and on gypsum.
2. Install fiberglass panels.
3. Install 2nd column.

6. INSTALLATION OF THE GLASS PANELS

7. INSTALLATION OF THE TOP and wiring of recessed lights by an electrician (see preceding page for details).

8. INSTALLATION OF THE DOOR(S), the hinges and the knob.

9. INSTALLATION OF THE OPTIONAL TOWEL BAR

10. LAYING THE CERAMIC TILES at the end, after completion of the shower installation.

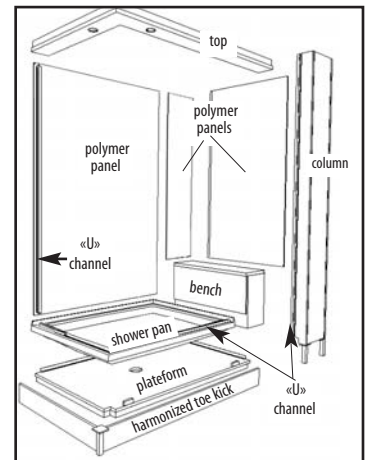

CAUTION! If the customer **ALREADY HAS CERAMIC TILES ON ALL WALLS** including the shower, you must inform us of this fact so we can make the necessary adjustments.



Nu & Linea Shower

Dimensions

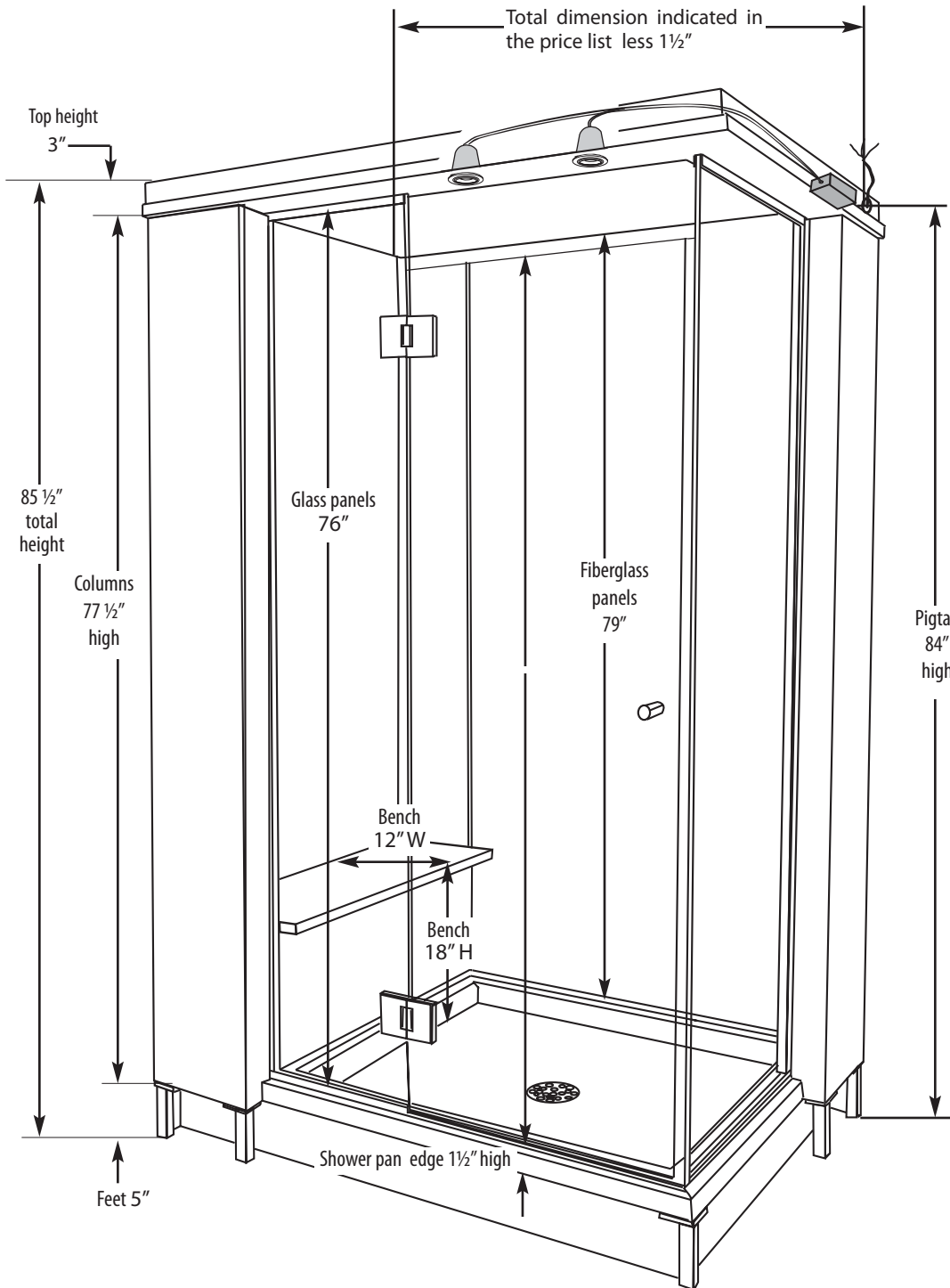

ELECTRICITY

110V pigtail at 84" high. Connect to the electrical transformer provided in the top of the shower.

The connection must be done by an electrician.

DRAIN

Place the drain at the dimension shown in the price list. For more information, see page 11.